



*Aluminum Extrusions for the Sign Professional*

# *Quick Reference Guide*

EXCELLART SIGN PRODUCTS, LLC.  
1654 S. Lone Elm Rd.  
Olathe, KS 66061  
**(800) 627-9044** | Fax: (913) 780-4620  
[sales@excellart.com](mailto:sales@excellart.com) | [www.Excellart.com](http://www.Excellart.com)

# Excellart Sign Products

## Quick Order/Quote Guide

For Knockdown Kits

Distributor: \_\_\_\_\_

Ship To: \_\_\_\_\_

Please **Quote** | **Order** the following sign(s): (Circle one)

Quantity: \_\_\_\_\_

Dimensions: \_\_\_\_\_ ' \_\_\_\_\_ " Tall x \_\_\_\_\_ ' \_\_\_\_\_ " Wide

Circle One: Outside Dimension or Face Size

Circle One: Retrofit/Existing Cabinet or New Sign/Cabinet

How deep of a cabinet is required? \_\_\_\_\_

Single Face or Double Faced? S/F or D/F Type of Face: Rigid or Flex

Illuminated? Yes or No If yes, vertical or horizontal or LED Lighting

Frame System: Narrowline EC-4 EC-6/6R EC-7 EC-8 EC-9/9R

EC-S/F EC-D/F EC-12 EC-IDS EC-Changeable Copy

EC-Flex EC-3.25 Architectural

Frame Type: Slide-in Hinged Flex Frame Radius Corners

Custom/Kerf-Cut Changeable Copy

How will this sign be mounted? Wall Pole Pedestal Other \_\_\_\_\_

Finish: Mill Bronze Powdercoat (RAL# \_\_\_\_\_)

# Excellart Sign Products

## EC Frame System

*Point of Purchase Systems  
featuring our exclusive  
"Snap" Retainer System.*

EC-4RN

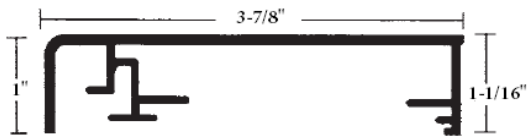

EC-4N

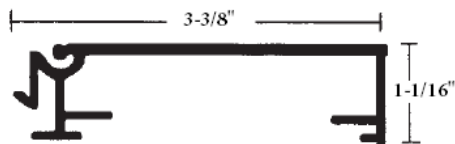

EC-4R

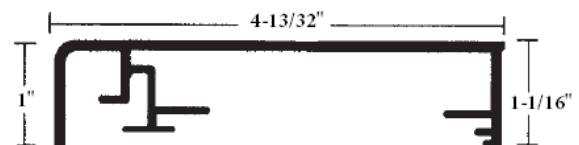

EC-4

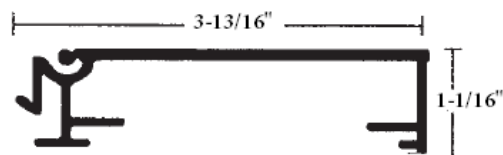

EC-7R

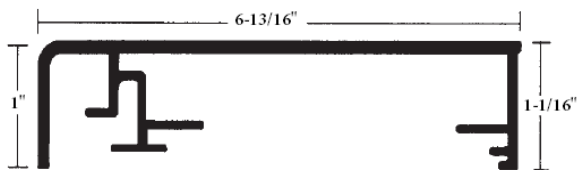

EC-7

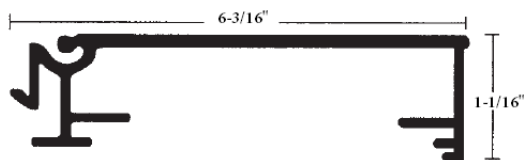

EC-8R

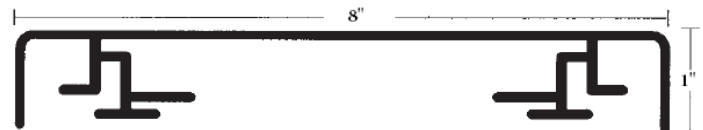

EC-8

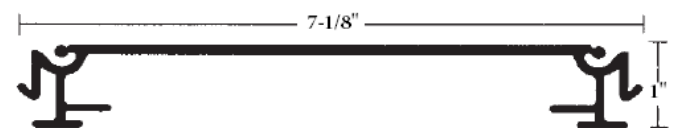

EC-4, 7, 8 &  
Narrowline Retainer

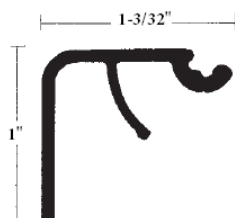

1" Radius Corner  
Connector & Cap  
(For Narrowline System Only)

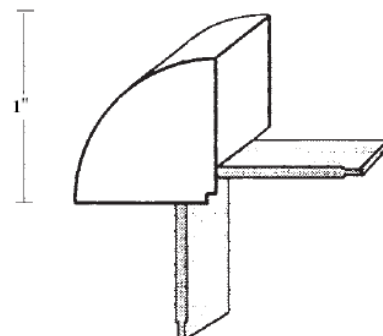

# Excellart Sign Products

## EC Frame System

### *Standard Mount Frames*

EC-S/F Standard Frame

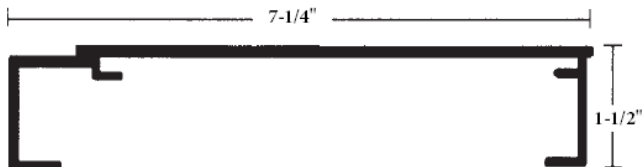

EC-D/F Standard Frame

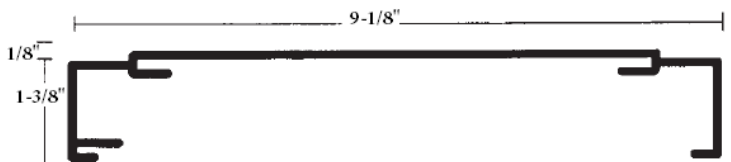

EC-12 Standard Frame

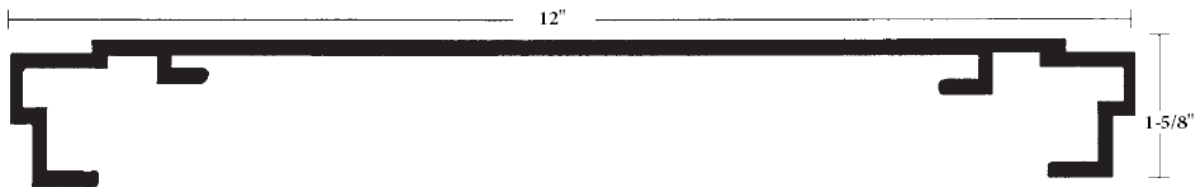

### *Hinged Frames*

EC-S/F Hinged Frame

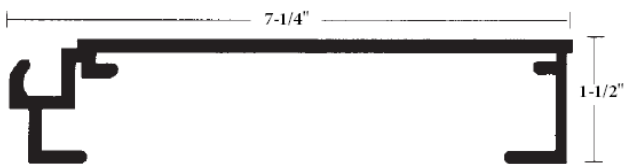

EC-D/F Hinged Frame

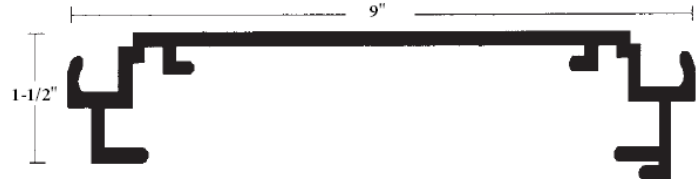

EC-12 Hinged Frame

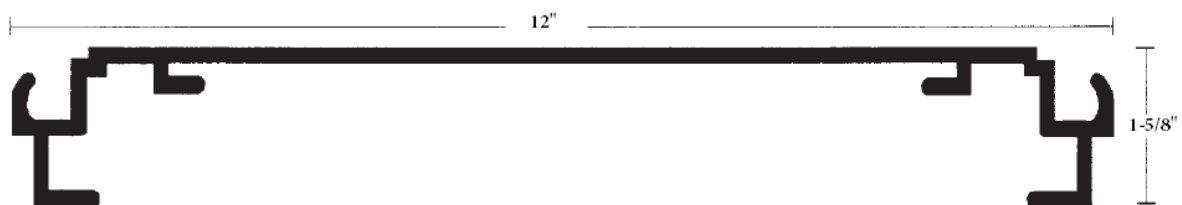

# Excellart Sign Products

## EC Frame System

### EC-IDS Frame System

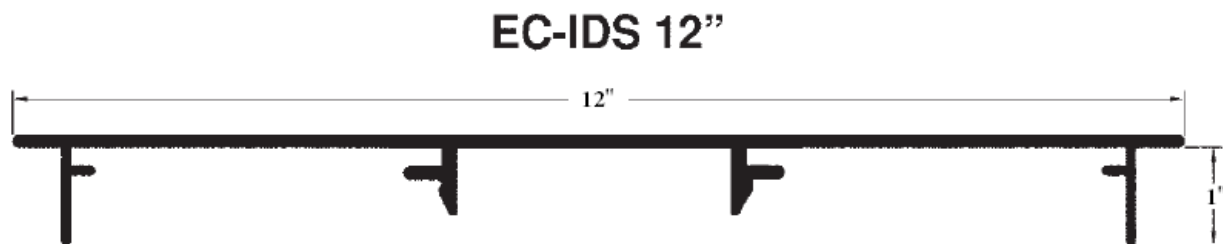
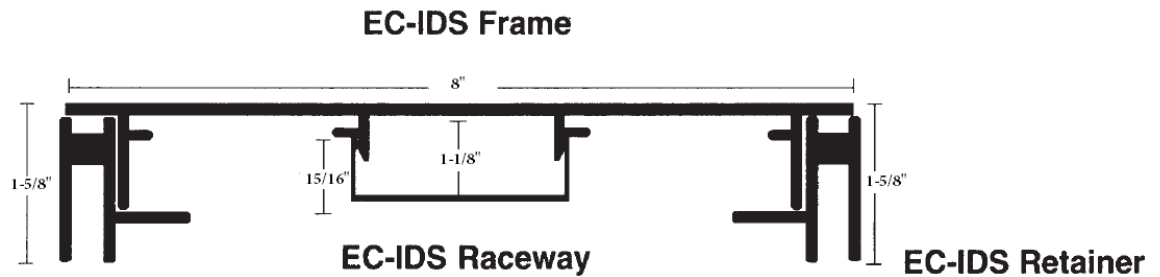

### Fixed Retainer Systems

#### EC-6R System

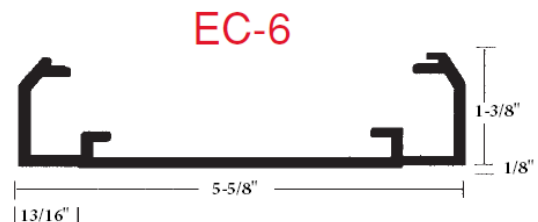
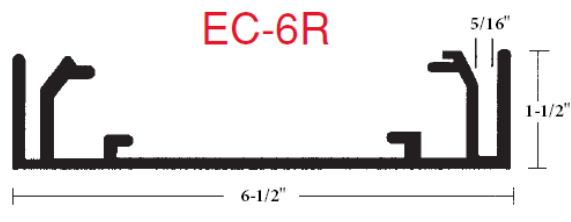

#### EC-9R System

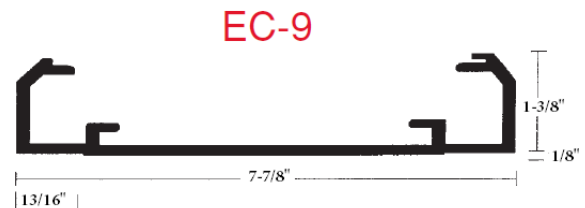
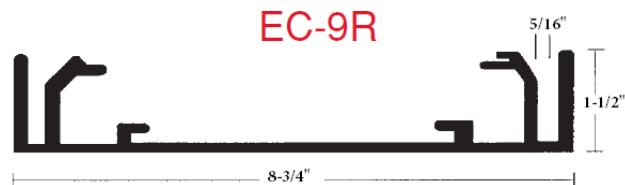

The LF Retainer mounts to the EC-6 & EC-9 Frames to complete the 6R & 9R Systems

#### LF Retainer

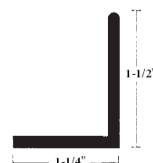

# Excellart Sign Products

## EC Frame System

### EC Retainers

F Retainer

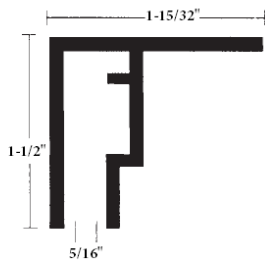

F Hinged Retainer

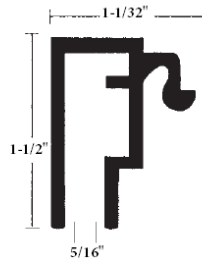

FF Retainer Short

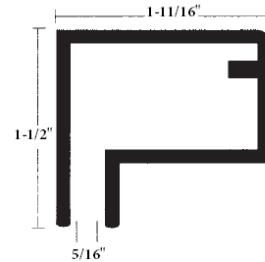

FF Flat Face Retainer

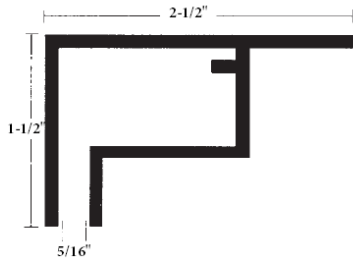

FF Hinged Retainer

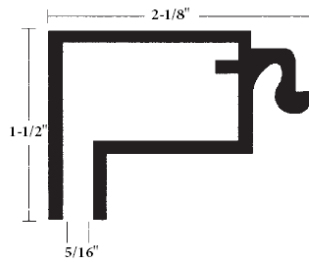

FF-2 Standard Retainer

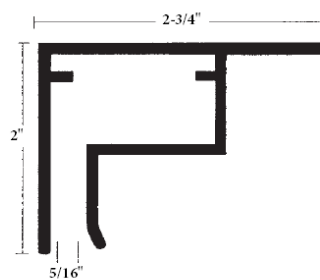

FF-2 Hinged Retainer

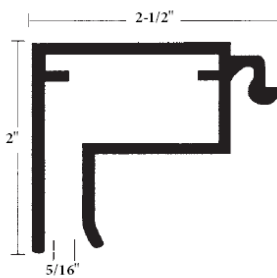

EC-Xtra Wide Retainer

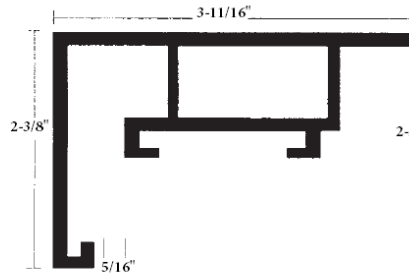

EC-Xtra Hinged Retainer

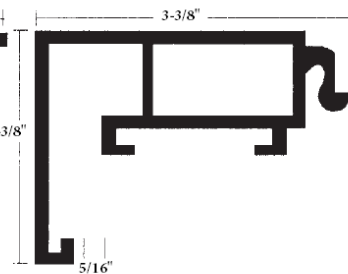

LF Retainer

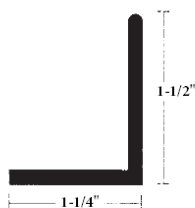

LF-2 Retainer



H-1 Retainer

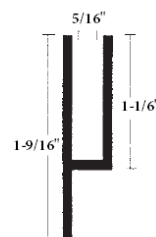

H-1.5 Retainer

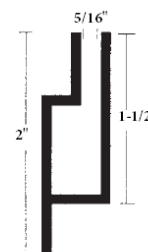

# Excellart Sign Products

## EC Frame System

### Flex Face Systems

Standard Frame with Standard Cover

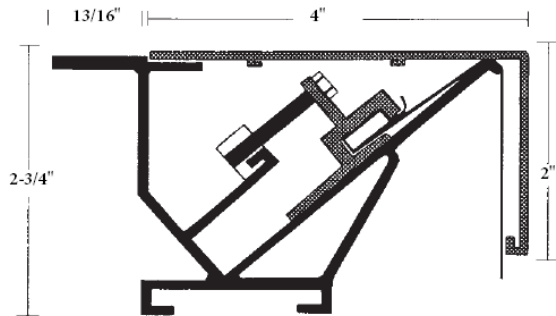

Hinged Frame with Standard Cover

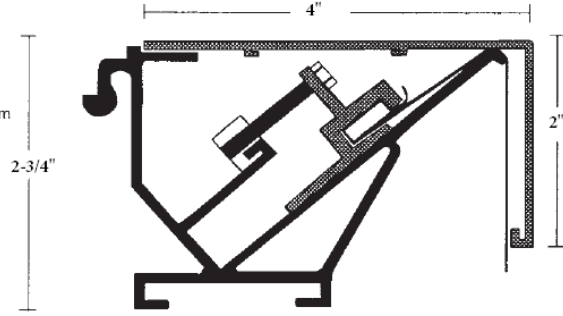

EC-Flex Retro Fit System

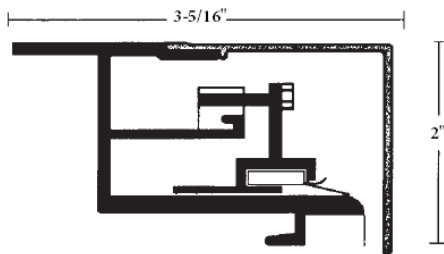

Standard Frame with Bleed Cover

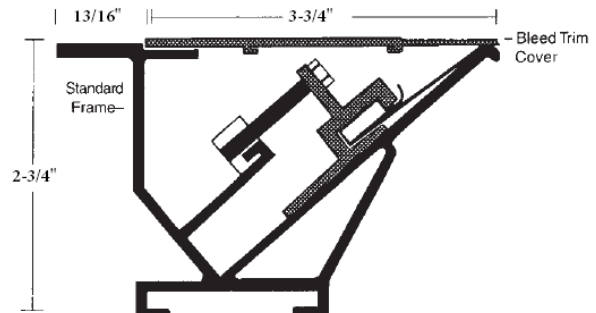

### Architectural Systems

EC-3.25 Radius Post

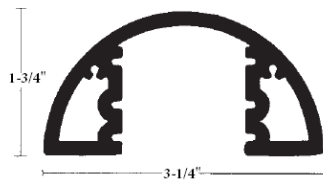

EC-3.25 Rectangular Post

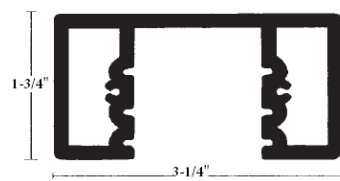

8" Radius Quarter End

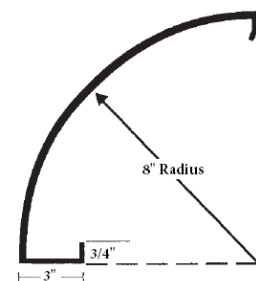

EC-Reveal Connector



EC-3.25 Bleed Frame

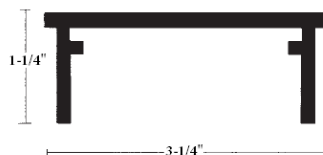

# Excellart Sign Products

## Raceways

EC-Socket Raceway

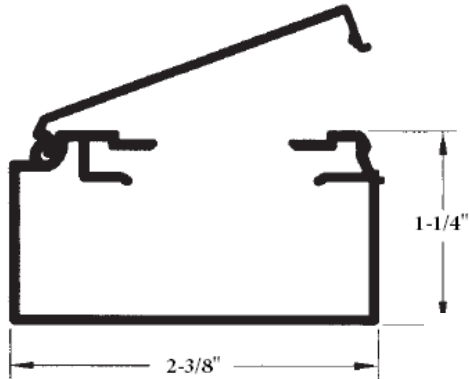

EC-Lamp/Ballast Track

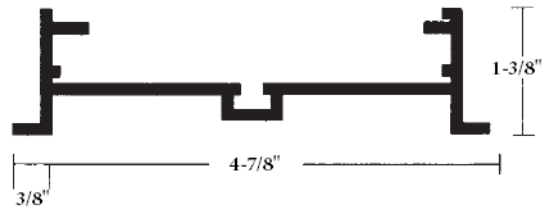

EC-Lamp Raceway

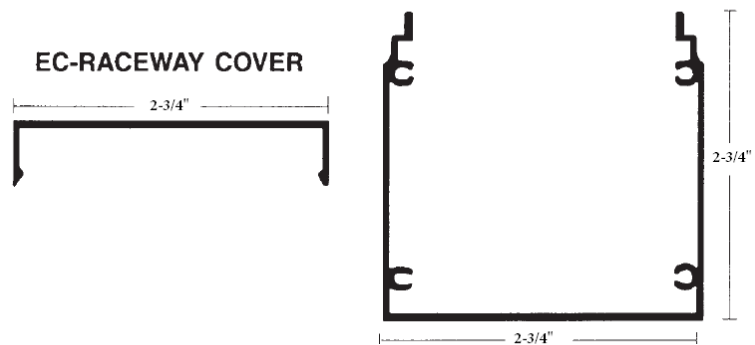

EC-Channel Letter Raceway

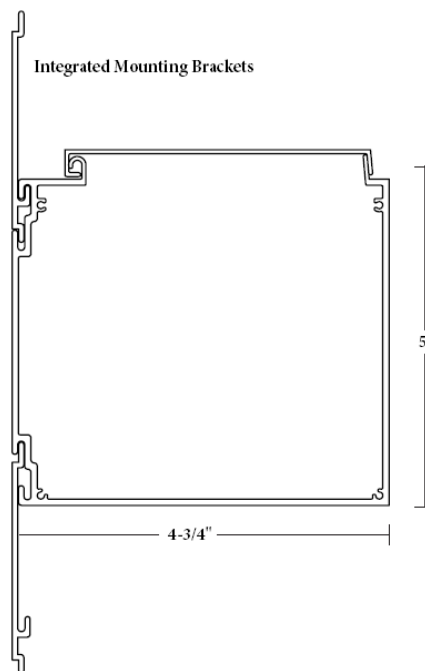
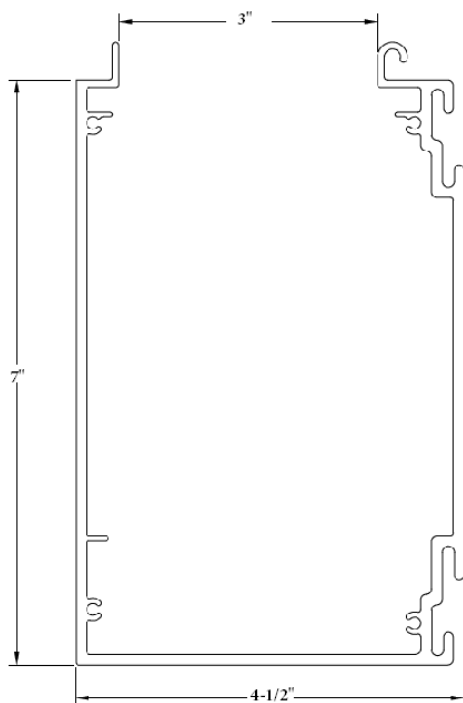



# Excellart Sign Products

## Original Frames & Retainers

### Excellart Frames & Retainers

M-C Frame

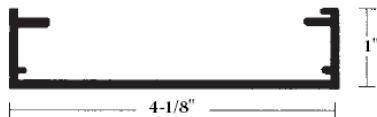

MC-R Frame

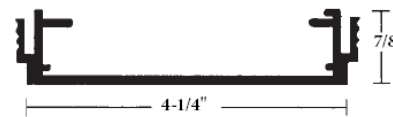

C Frame



C-2 Frame

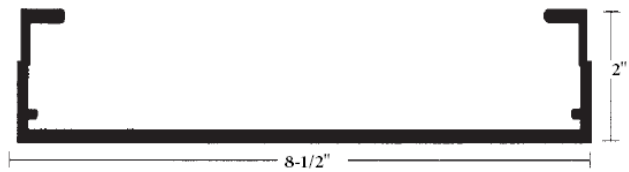

M-C Alternate

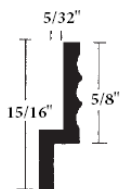

M-C

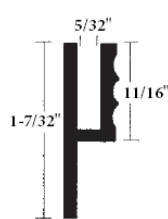

ZF.188

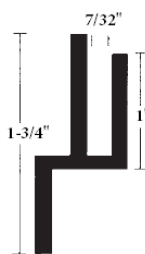

ZF.250

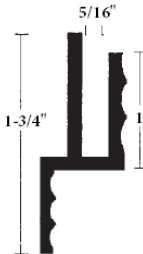

ZF-1 1/2

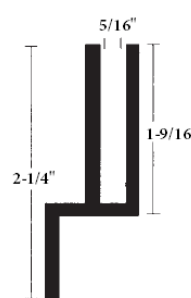

ZF-2

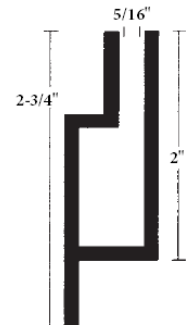

### Divider Bars

1 1/2"

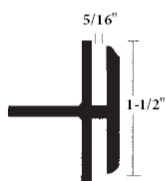

2 1/2"

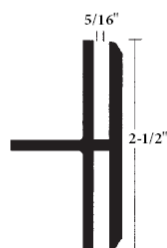

H Bar



Changeable Copy

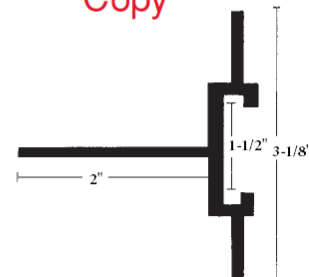

# Excellart Sign Products

## Commercial Frame Systems – Configurations For Rigid Faces

### EC-6 Frame System

EC-6R Frame System

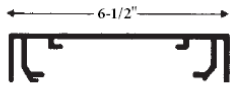

EC-6 Frame w/ LF & FF Retainers

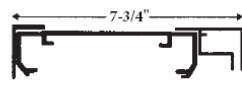

EC-6 Frame w/ FF Retainers

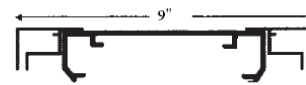

### EC-9 Frame System

EC-9R Frame System

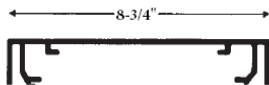

EC-9 Frame w/ FF Retainers

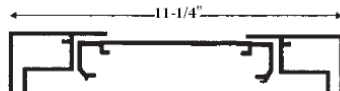

EC-9 Frame w/ FF-2 Retainers

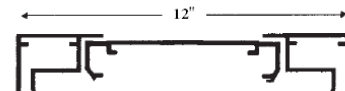

### EC-S/F Standard Frame System

EC-S/F Std w/ LF Retainer

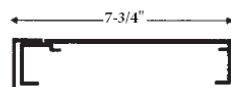

EC-S/F Std w/ FF Retainer

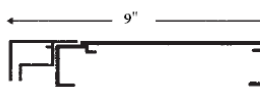

EC-S/F Std w/ FF-2 Retainer

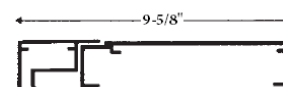

### EC Standard Frames with F Retainer

EC-S/F Std w/ F Retainer

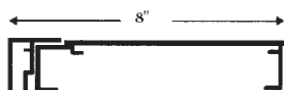

EC-D/F Std w/ F Retainer

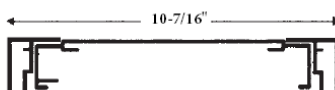

EC-12 Std w/ F Retainer

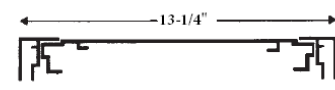

### EC-D/F Standard Frame System

EC-D/F Std w/ LF Retainer

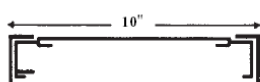

EC-D/F Std w/ FF Retainer

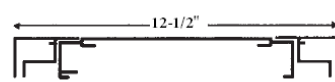

EC-D/F Std w/ FF-2 Retainer

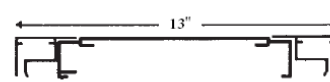

### EC-12 Standard Frame System

EC-12 Std w/ LF Retainer

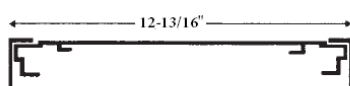

EC-12 Std w/ FF Retainer

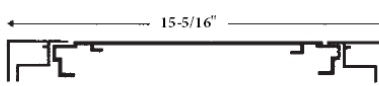

EC-12 Std w/ FF-2 Retainer

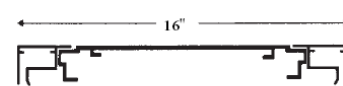

### EC-S/F Hinged Frame System

EC-S/F Hng w/ FF Hng Retainer

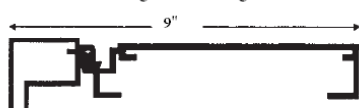

EC-S/F Hng w/ FF-2 Hng Retainer

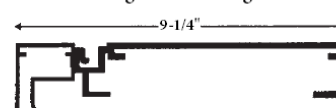

### EC-D/F Hinged Frame System

EC-D/F Hng w/ FF Hng Retainers

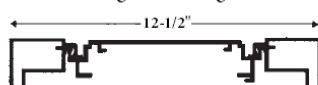

EC-D/F Hng w/ FF-2 Hng Retainers

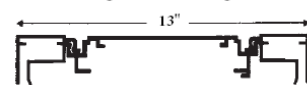

# Excellart Sign Products

## Commercial Frame Systems - Configurations

### For Rigid Faces - continued

#### EC-12 Hinged Frame System

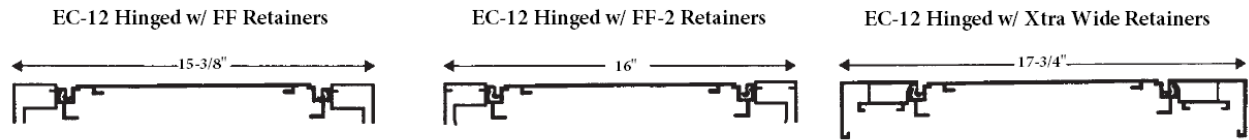

#### EC-Hinged Frames with F Retainer

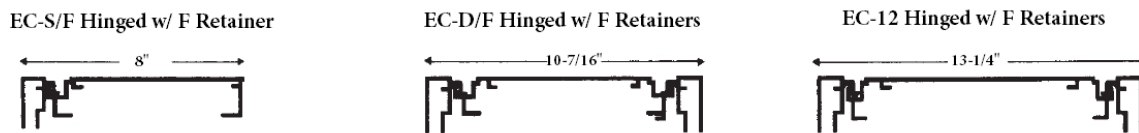

### For Flexible Fabric Faces

#### EC-S/F Hinged Flex Frame System

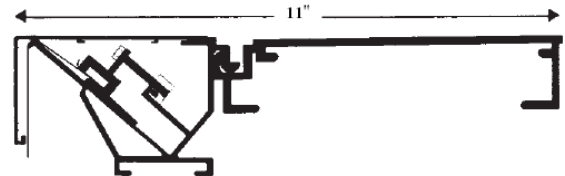

#### EC-D/F Hinged Flex Frame System

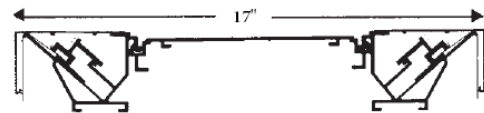

#### EC-12 Hinged Flex Frame System

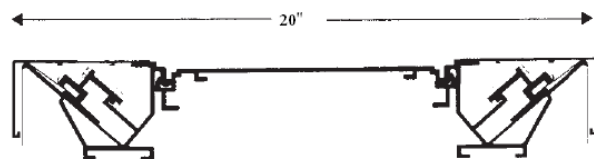

#### *EC-Flex Retro Fit Frame Applications*

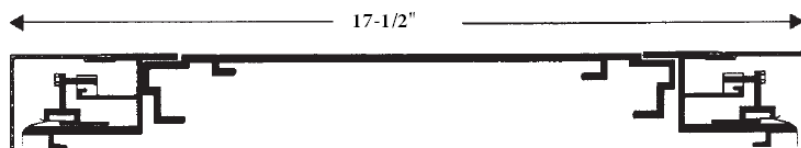
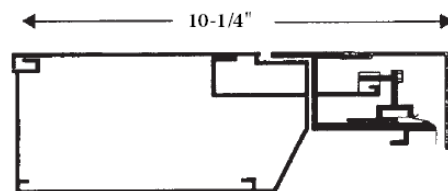
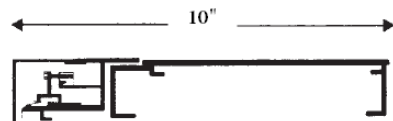

# Excellart Sign Products

## Specialty Sign Applications

### Changeable Copy Signs for Schools & Churches

EC-S/F Hinged Frame w/  
H-1 & FF-2 Retainers

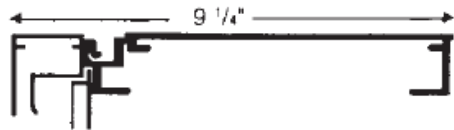

EC-D/F Hinged Frame w/ H-1.5  
or H-1 & FF-2 Retainers

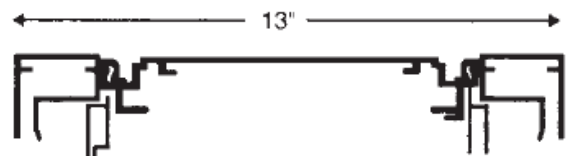

EC-12 Hinged Frame w/ H-1.5  
or H-1 & FF-2 Retainers

